

Class A AIS Transceiver

QUICK START GUIDE



For full instructions on how to install and use your AIS Transceiver please refer to the product manual.

Step 1 – Install the transceiver

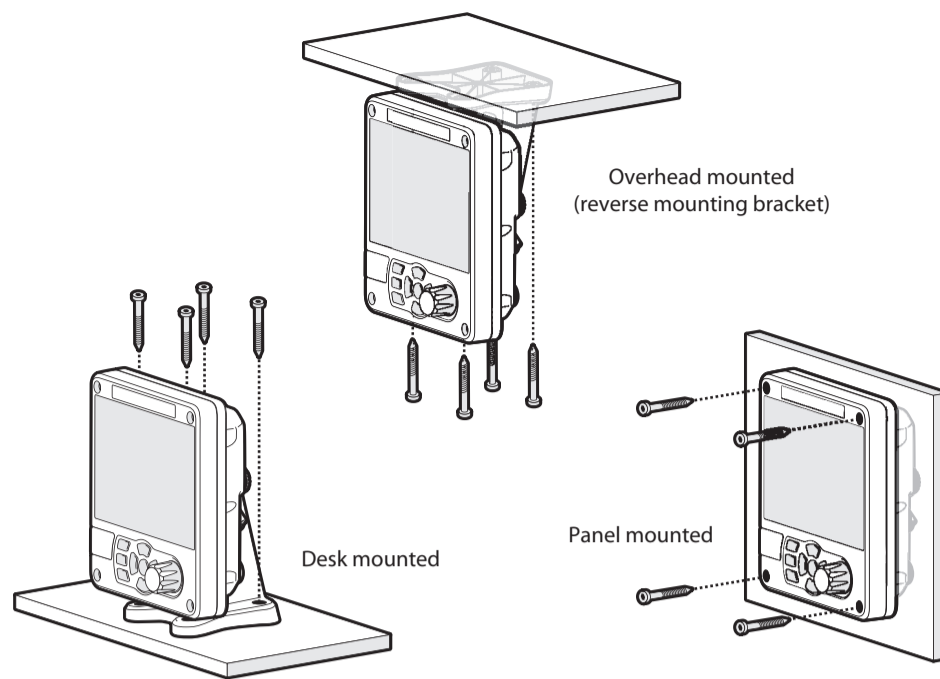

What's in the box?

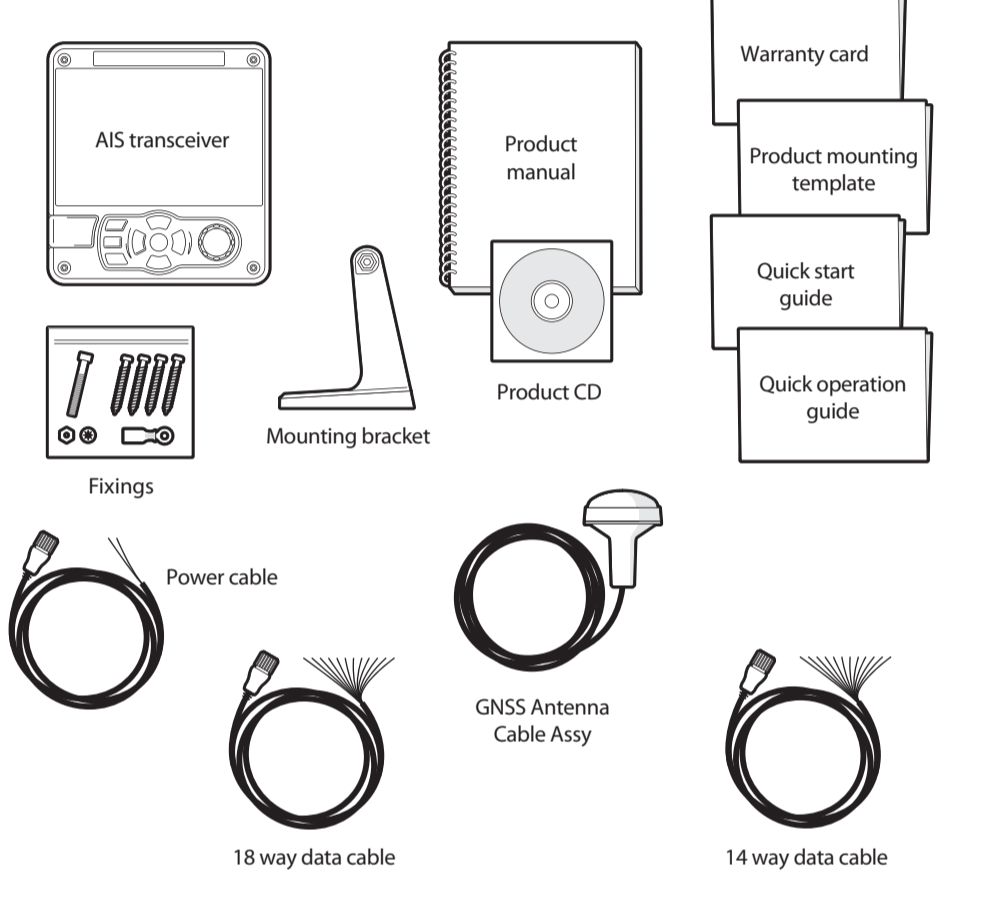

Step 2 – Install the antennas

GNSS antenna should be at least 5m (16ft) from radar or satellite communication antennas. It should also be away from the radar beam path and mounted on a rigid surface.

VHF antenna should be at least 3m (10ft) from other transmitting radio, satellite and radar antennas.

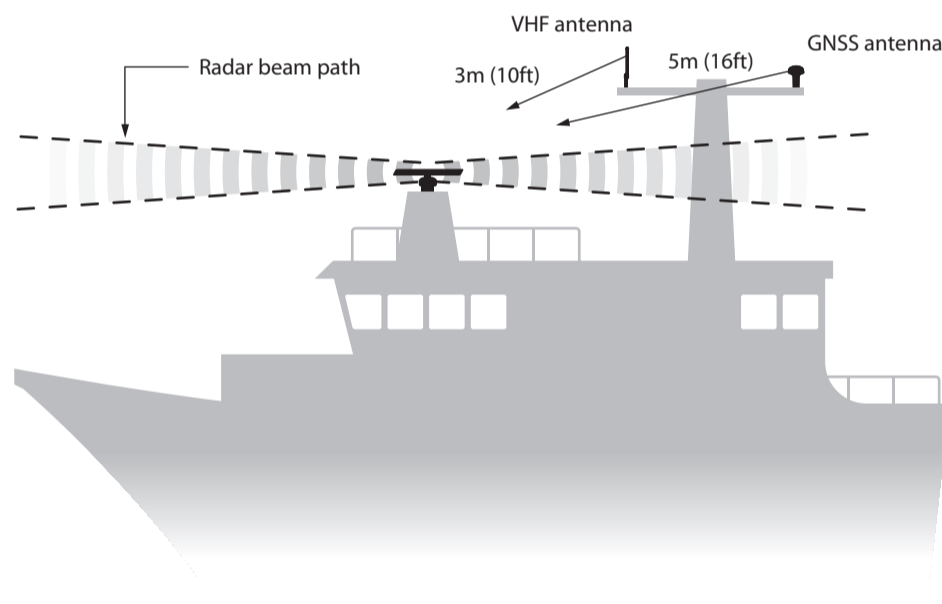

What do I need?

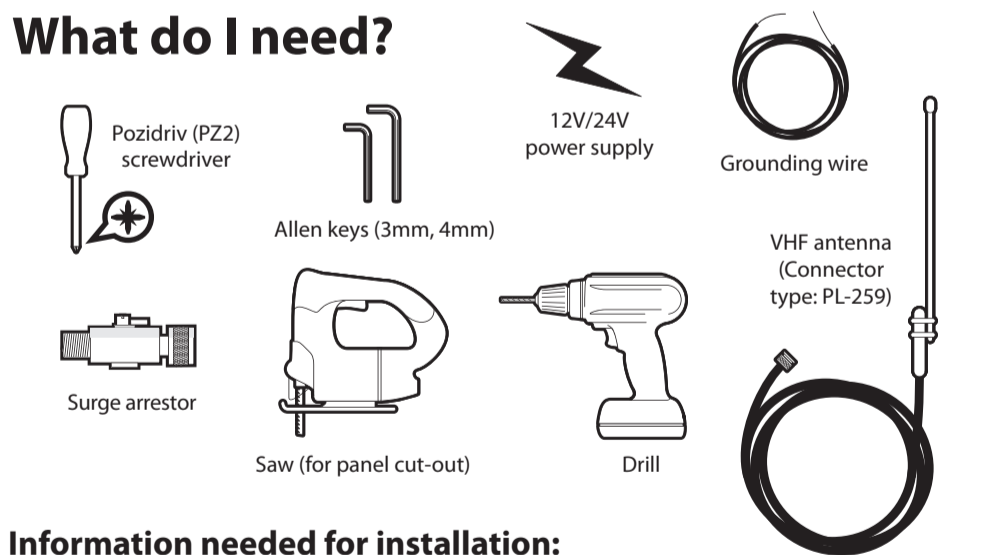

Information needed for installation:

Vessel type: Class A / SOLAS or Inland

MMSI number (9 digits): _____

Vessel name: _____

Vessel callsign: _____

IMO number (if available): _____

Vessel dimensions and GNSS antenna position:

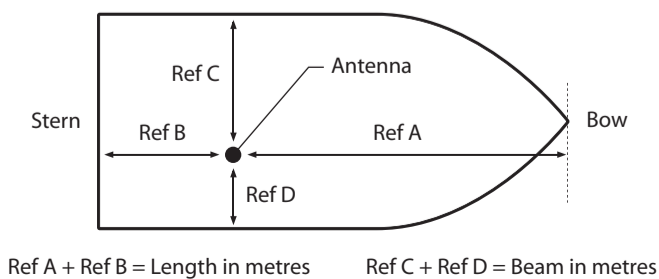

Front panel controls

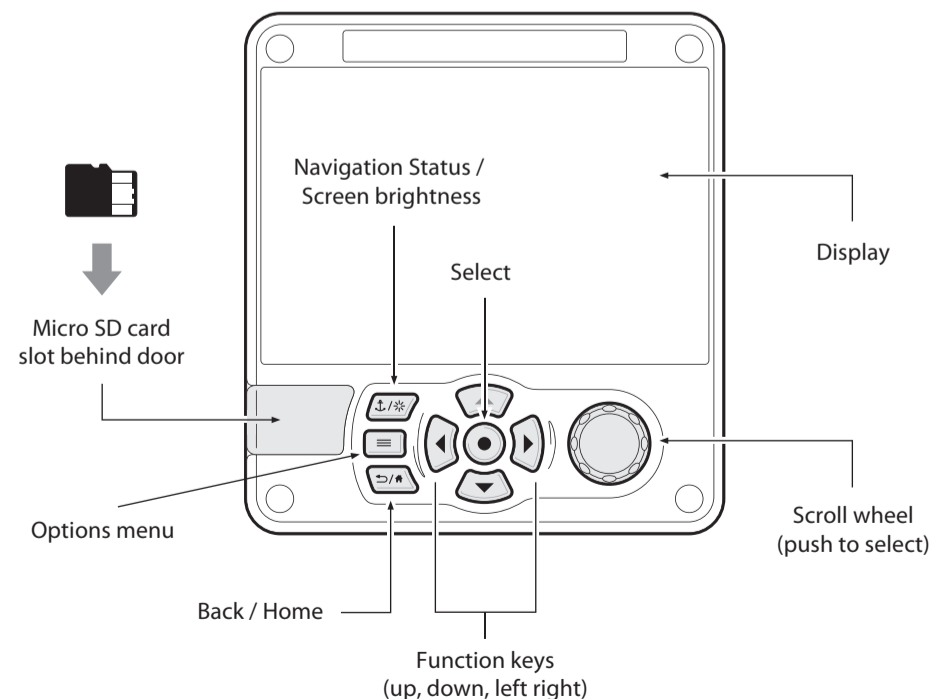

Step 3 – Connecting the transceiver

NOTE: Numbers and tables refer to connector pins on unit



Chassis/GND

This product must be connected to protective earth via the earth connection point. It is essential that the earth connection point is used in all installations, regardless of what other equipment is connected. The earth connection point must be bonded to protective earth using as short a connection as possible.

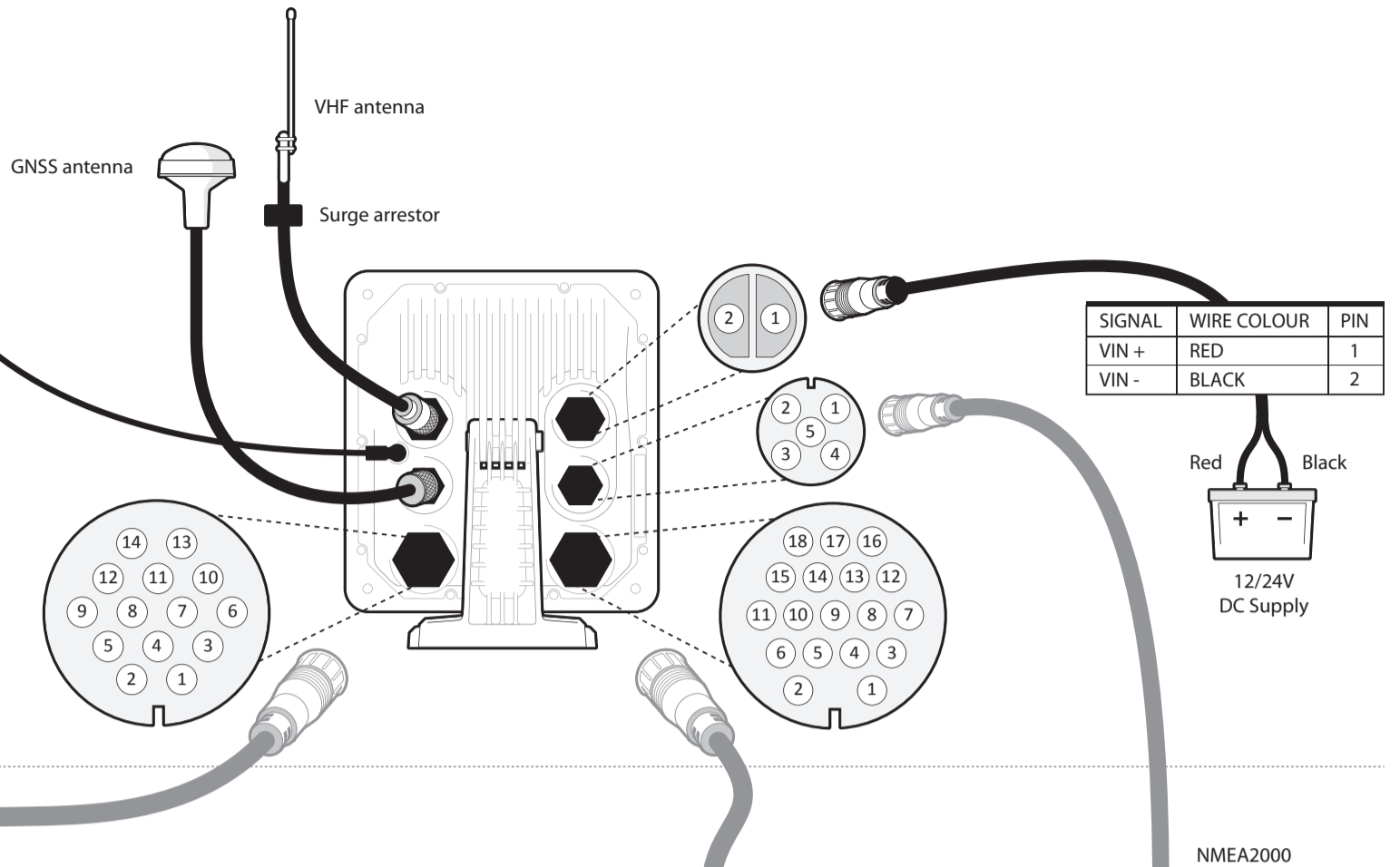

Optional connections

SIGNAL	WIRE COLOUR	PIN
BLUE SIGN N	BLACK	1
BLUE SIGN P	BROWN	3
SILENT N	BLUE	6
SILENT P	RED	7
SENSOR 1 RX B	ORANGE	2
SENSOR 1 RX A	PURPLE	5
SENSOR 1 COM	GREEN	8
SENSOR 2 RX B	WHITE	9
SENSOR 2 RX A	WHITE/BLACK	12
SENSOR 2 COM	GREY	11
SENSOR 3 RX B	YELLOW	14
SENSOR 3 RX A	RED/BLACK	13
SENSOR 3 COM	PINK	10
CHASSIS	DRAIN WIRE	4

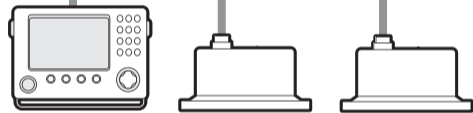

Ship's sensor data (DGPS, GYRO, Heading)

SIGNAL	WIRE COLOUR	PIN
LR DGPS TX B	ORANGE	3
LR DGPS TX A	BROWN	4
LR DGPS RX B	PURPLE	7
LR DGPS RX A	BLUE	8
LR DGPS COM	BLACK	1
PILOT TX B	RED	2
PILOT TX A	RED/WHITE	5
PILOT RX B	PINK	6
PILOT RX A	YELLOW	10
PILOT COM	GREEN	11
ALARM NC	GREY	16
ALARM COM	WHITE	12
EXT DISPLAY TX B	ORANGE/WHITE	13
EXT DISPLAY TX A	BLACK/WHITE	17
EXT DISPLAY RX B	BROWN/WHITE	14
EXT DISPLAY RX A	YELLOW/WHITE	18
EXT DISPLAY COM	GREEN/WHITE	15
CHASSIS	DRAIN WIRE	9



Displays (ECDIS, Radar)

SIGNAL	PIN
N2K_NET_SHIELD	1
N2K_NET_S	2
N2K_NET_C	3
N2K_NET_H	4
N2K_NET_L	5

An optional junction box is available to assist with wiring to sensors and displays

Step 4 – Quick start sequence

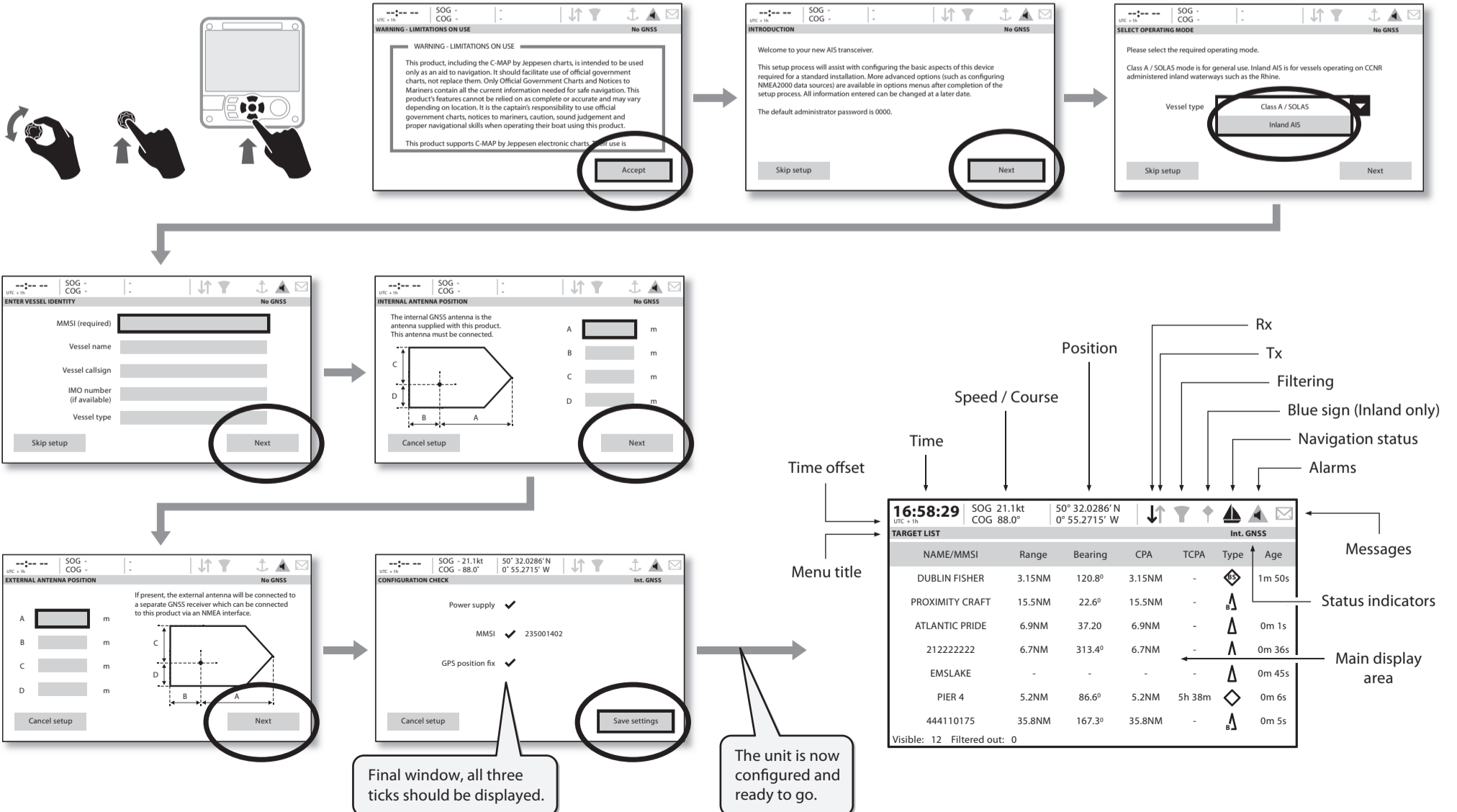

Final window, all three ticks should be displayed.

The unit is now configured and ready to go.